



Rolled ball screws

Efficiency in motion



TECHNICAL & DIMENSIONAL

Contents

Rolled Ball Screws

Efficiency in motion

01	APPLICATIONS	04
02	PRODUCTION RANGE	05
03	RETURN SYSTEMS	06
04	WIPERS	06
05	MATERIALS & TREATMENT	07
06	LUBRICATION	07
06.1	Oil	08
06.2	Grease	08
06.3	Amount of lubricant	08
06.4	Frequency	09
07	TERMS AND GEOMETRIC DEFINITIONS	09
08	QUALITY	10

09	LOADS	14
10	CALCULATIONS	14
10.1	Lifes	14
10.2	Torque & power	17
10.3	Types of support at ends of screw	18
10.4	Critical speed	19
10.5	Column load	21
10.6	Rigidity	22
11	NUT HANDLING	24
12	CODIFICATION	25
13	DIMENSIONAL TABLES	26

Presentation

The IPIRANGA rolled ball screws are the most efficient solution for linear translation drives that require speed and load, and do not require the configuration and precision degree of a ground ball screw.

IPIRANGA uses a cold-rolling process to manufacture its rolled ball screws, according to standard DIN 69051, precision classes IT5 and IT7.

The product range covers the following selection:

- 16 to 63 mm diameter
- 5 to 50 mm pitch
- Up to 6 m long
- One or multiple starts

01

APPLICATIONS

Punching machines

Laser cutting machines

Actuators and handlers

Robotics

Winders

Testing machines

Transfer

Machines for plastic

Machines for wood

Saws and mitre saws

Presses and shears

Welding equipment

Rolling machines

Packaging machines

Elevation, platforms and lifts

Doors and gates

Valves

Beds and armchairs







Equipment for disabled persons

Other applications can be studied by our technical department to give advice in the implementation of rolled ball screws.



Diameters, pitches, shaft length and series

Diameter mm	Pitch mm	Length mm	Series					
			10	18	12	20	14	16
16	5	3,000	●	●	●	●		
20	5	6,000	●	●	●	●		
25	5	6,000	●	●	●	●		
25	10	6,000					●	●
25	25	6,000					●	●
32	5	6,000	●	●	●	●		
32	10	6,000	●	●	●	●		
32	40	6,000					●	●
40	5	6,000	●	●	●	●		
40	10	6,000	●	●	●	●		
40	40	6,000					●	●
50	10	6,000	●	●	●	●		
50	20	6,000					●	●
50	50	6,000					●	●
63	10	6,000	●	●	●	●		
63	20	6,000					●	●

Series and returns

Serie	10	12	14	16	18	20
	Standard cylindrical nut	Standard flange nut	Standard multi-starts nut	Standard multi-starts flange nut	DIN Flange nut	DIN cylindrical nut
Model						
Return	S	S	E	E	S	S

03 RETURN SYSTEMS

Return	Model	Main characteristics
E Shield		Multi-starts return and protector in one recirculating system. High-resistance polyamide.
U Liner		Recirculating system for one start and multi-starts, independent protector. High-resistance polyamide or steel.
S Deflector		Recirculating system for one start and multi-starts, independent protector. High-resistance polyamide or steel.

The return systems are designed for each different series.
Series 10, 18 and 20, 20, have **S** and **U** return systems.
Series 14 and 16 have **E** and **U** return systems.

04 WIPERS

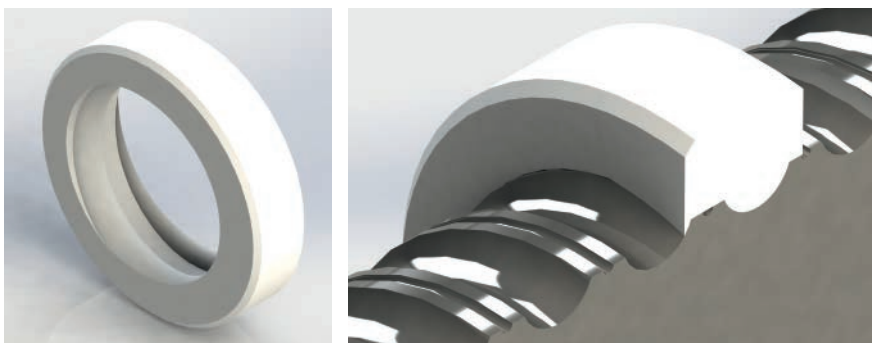

Characteristics

The protectors are manufactured in PTFE and POLYAMIDE, depending on the series.
The protectors are placed in the nuts to prevent particles from entering. Particles such as metallic powder could get inside.
The protector and screw do not have an airtight fit, letting oils and fine layers of grease come out during operation.

05
MATERIALS & TREATMENTS
Materials

Component	Material	Treatment	Hardness
Screw	CK 55	Induction hardening	58÷62
Nut	20MnCr5	Case hardening, hardening and annealing	60÷62
Balls	100Cr6		62÷65

Safety nuts

Component	Material	Treatment	Hardness
Safety nut	20MnCr5	Case hardening, hardening and annealing	60÷62
	CK45		26

Treatments

Blueing
Phosphating

Returns

Polyamide
Fe8Ni0,6C
Ck45

Returns

Polyamide
Fe8Ni0,6C
Ck45

06
LUBRICATION

Lubricating ball screws is essential for them to function properly. Its purpose is to:

- Reduce friction and wear. The lubricant film between balls and raceways prevents metal-metal contact.
- Increase fatigue life. The lubricant protects the ball screw elements, increasing lifespan as described on page 12.
- Dissipate some of the generated heat.
- Prevent corrosion and rusting.
- Eliminate particles and foreign bodies.

Selecting the type of lubrications (oil, grease), the quantity and application frequency all depend on the operating conditions and the work cycle of the ball screw.

06.1 | Oil

Viscosity at 40°

Viscosity class	Mean viscosity mm ² /s
ISO VG 2	2.2
ISO VG 3	3.2
ISO VG 5	4.6
ISO VG 7	6.8
ISO VG 10	10
ISO VG 15	15
ISO VG 22	22
ISO VG 32	32
ISO VG 46	46
ISO VG 68	68
ISO VG 100	100
ISO VG 150	150
ISO VG 220	220
ISO VG 320	320
ISO VG 460	460
ISO VG 680	680
ISO VG 1000	1000
ISO VG 1500	1500

06.2 | Grease

DIN NGL1 CLASS	DIN Full penetration	Fa<0,15 Cam Without additives	Fa>0,15 Cam With additives
0	Very fluid / Semi-Liquid 355-385	-	High load Up to 800 Rpm
1	Very smooth 310-340	Low load Up to 800 Rpm	-
2	Smooth 265-295	Normal load Up to 600 Rpm	Very high load Up to 600 Rpm
3	Mean firmness	High load Up to 400 Rpm	-

06.3 | Amount of lubricant

Diameter	Pitch	10	12	14	16	18	20
16	5	0.8/0.04	0.8/0.04			0.8/0.04	0.8/0.04
20	5	1/0.05	1/0.05			1/0.05	1/0.05
25	5	1.25/0.06	1.25/0.06			1.25/0.06	1.25/0.06
25	10			2.5/0.36	2.5/0.36		
25	25			6.25/1.48	6.25/1.48		
32	5	1.6/0.11	1.6/0.11			1.6/0.11	1.6/0.11
32	10	1.6/0.39	1.6/0.39			1.6/0.39	1.6/0.39
32	20			6.4/4.65	6.4/4.65		
32	40			6.4/2.57	6.4/2.57		
40	5	2/0.17	2/0.17			2/0.17	2/0.17
40	10	2/0.39	2/0.39			2/0.39	2/0.39
40	40			8/6.05	8/6.05		
50	10	2.5/0.82	2.5/0.82			2.5/0.82	2.5/0.82
50	20			5/2.96	5/2.96		
50	50			12.5/12.32	12.5/12.32		
63	10	3.15/1.03	3.15/1.03			3.15/1.03	3.15/1.03
63	20			6.3/3.73	6.3/3.73		
mm	mm	Volume of oil cm ³ / Grease cm ³					

06.4 | Frequency

		Speed				Type
		Fast	Intermediate	Slow		
Carga	<50% Cam	1/4 Hours	1/2 Hours	1 Hours	Oil	
		50 Hours	100 Hours	150 Hours	Grease	
	25%-50% Cam	1/2 Hours	1 Hours	1.5 Hours	Oil	
		100 Hours	150 Hours	200 Hours	Grease	
	<5% Cam	3/4 Hours	1.5 Hours	2 Hours	Oil	
		200 Hours	250 Hours	300 Hours	Grease	

07

TERMS AND GEOMETRIC DEFINITIONS

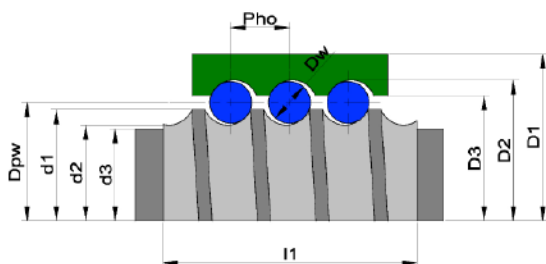

d_o =	Nominal diameter.	D_3 =	Inner diameter of nut.
d_1 =	Outer diameter of screw.	D_{pw} =	Primitive diameter.
d_2 =	Inner diameter of screw.	D_w =	Ball diameter.
d_3 =	Maximum diameter of support to mount the nut.	l_1 =	Pitch length.
D_1 =	Outer diameter of nut.	Φ_o =	Helical thread.
D_2 =	Base diameter of nut.	ϕ =	Helix angle.
		α =	Nominal contact angle.

The nominal diameter, d_o , is the value without tolerance used to designate the screw, normally coinciding with the outer diameter of the screw d_1 .

The primitive diameter, D_{pw} , is the diameter that passes through the centre of the balls when these are making contact in the screw and the nut at the theoretical contact points.

The raceway is the specially designed helical groove to transmit the reaction load between the nut and the screw through the balls.

The pointed groove is the raceway whose normal section is ogival-shaped.

The round groove is the raceway whose normal section is circular arc shaped.

Conformity f_r , is the relationship of the radius of the raceway of the screw, r_s , or of the nut r_n , with the diameter of the balls, D_w .

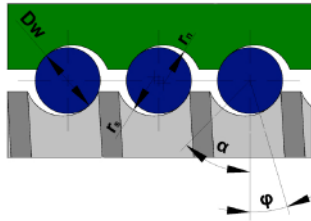

The sub-indices s and ni mean, respectively, screw and nut.

Nominal contact angle, α , is the angle between the vertical plane to the screw shaft and that resulting from the forces transmitted by a raceway to a rolling element.

Axial play, S_a , is the total axial displacement value between the nut and screw when there is no rotation between the components.

Radial play S_r , is the total radial displacement value between nut and screw.

Displacement I , is the axial displacement value of the screw or of the nut when one or other rotates.

Pitch P_h , is the axial displacement value between nut and screw for one revolution.

Nominal displacement I_o , is the result of multiplying the nominal helical pitch by the number of turns made.

08
QUALITY

IPIRANGA manufactures rolled ball screws according to DIN 69051, precision classes IT5 and IT7. All the control values are related to this classification.

The basic principle of the measurements is shown on the figure below.

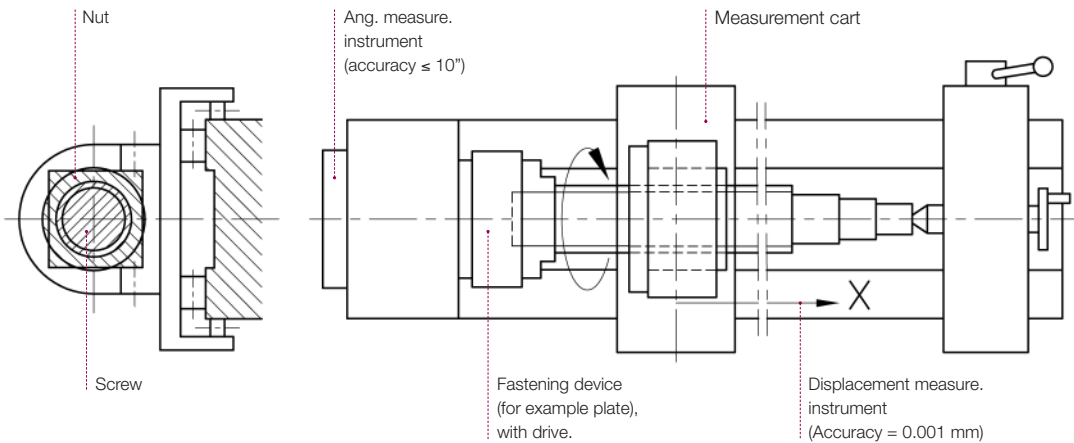

The tolerances that refer to the pitch accuracy are values V_{300p} , e_p , where the values for the different qualities are as follows:

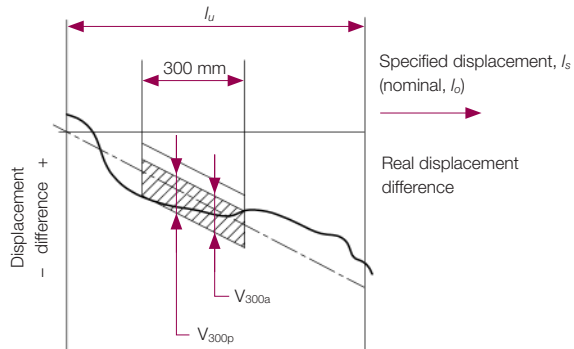

Positioning ball screw transport

Standardised degree of tolerance

		5	7	
V_{300a}				
μm				
		23	52	

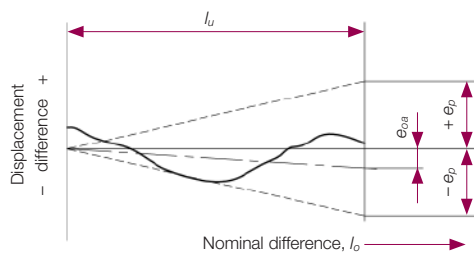

l_u mm		Standardised degree of tolerance		
above	Up to (inclusive)	5	7	
e_p μm				
	315	23	54	
315	400	25	56	
400	500	27	62	
500	630	32	70	
630	800	36	79	
800	1000	40	91	
1000	1250	47	106	
1250	1600	55	125	
1600	2000	65	149	
2000	2500	78	178	
2500	3150	96	214	
3150	4000	115	262	
4000	5000	140	322	
5000	6300	170	395	

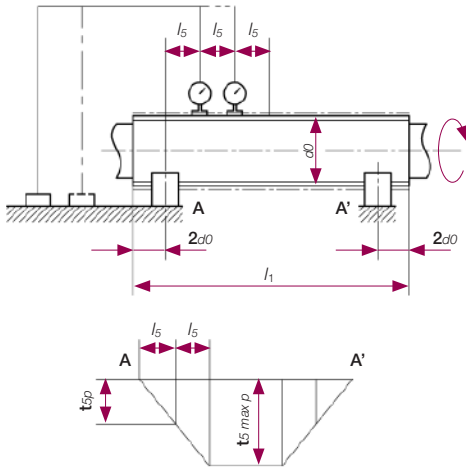

Positioning or transport ball screws

Nominal diameter d_0 mm			Standardised degree of tolerance			
above	Up to (inclusive)	l_5 mm	5		7	
			t_{5p} for l_5 μm			
6	12	80				
12	25	160				
25	50	315				
50	100	630	32		40	
100	200	1250				
l_1 / d_0			$t_{5 \max p}$ for $l_1 \leq 4 l_5$ μm			
above	Up to (inclusive)					
-	40			64	80	
40	50			96	120	
60	125			160	200	
80	315			256	320	

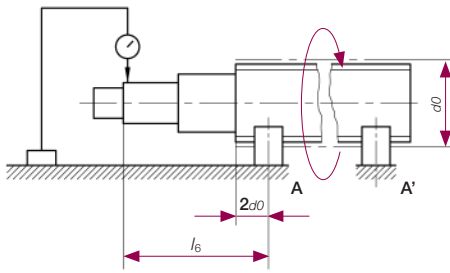

Positioning or transport ball screws

Nominal diameter d_0 mm			Standardised degree of tolerance			
above	Up to (inclusive)	l mm	5		7	
			t_{5p} for l μm			
6	20	80		20	40	
20	50	125		25	50	
50	125	200		32	63	
125	200	315		10	80	

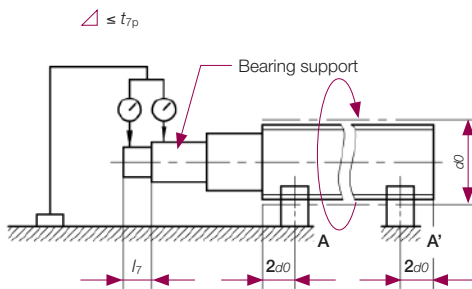

Positioning or transport ball screws

Nominal diameter d_0 mm			Standardised degree of tolerance			
above	Up to (inclusive)	l mm	5		7	
			t_{5p} for l μm			
6	20	80		8	12	
20	50	125		10	16	
50	125	200		12	20	
125	200	315		16	25	

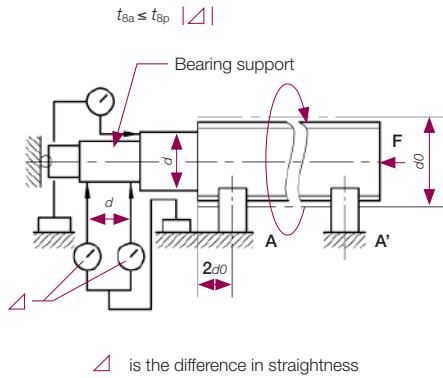

Positioning or transport ball screws

Nominal diameter d_0 mm		Standardised degree of tolerance			
above	Up to (inclusive)			5	7
		t_{Bp} μm			
6	63			5	6
63	125			6	8
125	200			8	10

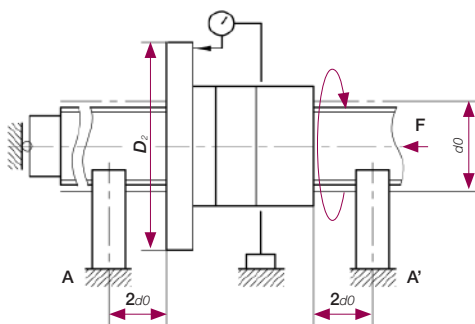

Positioning or transport ball screws

Nominal diameter D_2 mm		Standardised degree of tolerance			
above	Up to (inclusive)			5	7
		t_{Bp} μm			
16	32			16	20
32	63			20	25
63	125			25	32
125	250			32	40
250	500			40	50

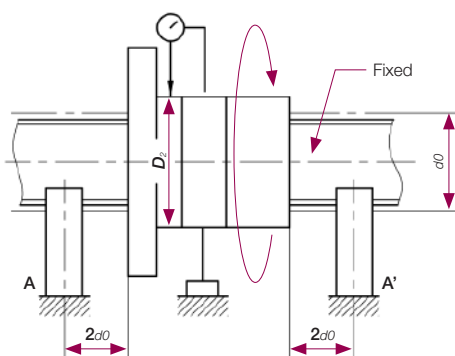

Positioning or transport ball screws

Nominal diameter D_1 mm		Standardised degree of tolerance			
above	Up to (inclusive)			5	7
		t_{10p} μm			
16	32			16	20
32	63			20	25
63	125			25	32
125	250			32	40
250	500			40	50

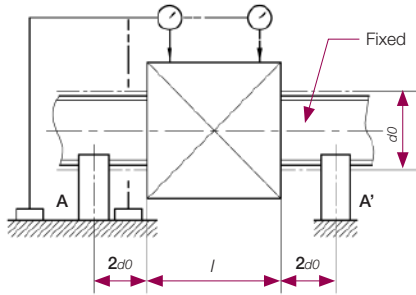

Positioning or transport ball screws

Standardised degree of tolerance

		5	7	
t_{11p} for every 100mm (cumulative difference) μm				
		25	32	

09
LOADS

The dynamic load refers to the load that is concentric to the shaft in motion, with which an identical group of screws reaches a lifespan of one million revolutions.

The lifespan of one million revolutions means that obvious signs of fatigue appear.

The static load is the load that is concentric to the shaft at rest, which produces a plastic deformation of $0.0001 \times Dw$ (ball diameter). This deformation occurs between the ball and the raceways.

10
CALCULATIONS

10.1 | Lifespan

General calculation and Calculation for nut without preload with unidirectional axial load.

To calculate the lifespan in a general way, it suffices to know the mean speed, mean load and operating time.

Calculation of mean speed with variable speed

n_m =Mean speed (Rpm)

q =Time (%)

n =Speed (Rpm)

$$n_m = \sum_{j=1}^n \frac{q_j}{100} \times n_j$$

Calculation of mean force with variable axial load and variable rotation speed.

F_m =Mean force (Newton)

F =Force (Newton)

q =Time (%)

n =Speed (Rpm)

$$F_m = \sqrt[3]{\sum_{j=1}^n F_j^3 \times \frac{n_j}{n_m} \times \frac{q_j}{100}}$$

Calculation of mean force with variable axial load and constant rotation speed.

F_m =Mean force (Newton)

F =Force (Newton)

q =Time (%)

n =Speed (Rpm)

$$F_m = \sqrt[3]{\sum_{j=1}^n F_j^3 \times \frac{q_j}{100}}$$

Lifecycle of a screw without preload with unidirectional axial load.

L_m =Life (Turns)

L_{hm} =Life (Hours)

F_m =Mean force (Newton)

C_{am} =Dynamic load (Newton)

$$L_m = \left[\left(\frac{C_{am}}{F_m} \right)^3 \times 10^6 \right] \times F_{ar} \quad L_{hm} = \frac{L_m}{60 \times n_m}$$

Reliability %	F_{ar}
90	1
95	0.62
96	0.53
97	0.44
98	0.33
99	0.21

Calculation for nut without preload with bidirectional axial load.

To calculate the lifespan of a nut without preload with bidirectional axial load, we must calculate the speed and mean load of both directions and the operating time in both directions*.

The mean speed n_m is calculated with the general formula.

* The mean speed n_m is calculated with the general formula.

Calculation of mean force with variable axial load and variable rotation speed.

$F_{m1,2}$ =Mean force (Newton)

F=Force (Newton)

q=Time (%)

n=Speed (Rpm)

$$F_{m1,2} = \sqrt[3]{\sum_{j=1}^n F_{1,2j}^3} \times \frac{n_j}{n_m} \times \frac{q_j}{100}$$

Calculation of mean force with variable axial load and constant rotation speed.

$L_{m1,2}$ =Life (Turns)

F=Force (Newton)

q=Time (%)

n=Speed (Rpm)

$$F_{m1,2} = \sqrt[3]{\sum_{j=1}^n F_{1,2j}^3} \times \frac{q_j}{100}$$

Lifecycle of a screw without preload with bidirectional axial load.

$L_{m1,2}$ =Life (Turns)

L_{hm} =Life (Hours)

$F_{m1,2}$ =Mean force (Newton)

C_{am} =Dynamic load (Newton)

$$L_{m1,2} = \left[\left(\frac{C_{am}}{F_{m1,2}} \right)^3 \times 10^6 \right] \times F_{ar} \quad L_{hm} = \frac{L_{m1,2}}{60 \times n_m}$$

Reliability %	F_{ar}
90	1
95	0.62
96	0.53
97	0.44
98	0.33
99	0.21

10.2 | Torque & power

Torque

The friction coefficient in ball screws is very low due to the tread between the unit components. The performance depends on the work conditions and the geometry, as well as on the manufacturing quality.

The ball screws made by IPIRANGA undergo a high-quality technical process to ensure mechanical performance of close to 100%, determined by the helix and friction angles.

In all cases a driving element is connected to the screw either directly or by means of reductions or transmissions.

The necessary torque to transform the rotating movement into linear movement, surpassing the axial loads, is calculated as follows. Converting the rotation into movement.

T_a =Motor torque. (Nm).
 η =Mechanical performance (≥ 0.9)
 φ =Helix angle.
 F =Axial force.
 P_{ho} =Pitch. (mm).
 D_{pw} =Primitive diameter. (mm).

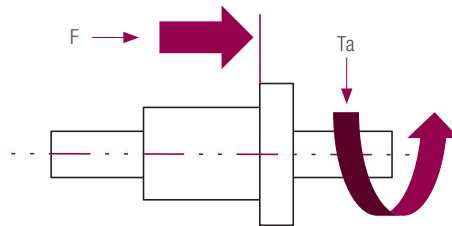

$$\varphi = \arctan \frac{\text{Pitch}}{\pi \times D_{pw}}$$

$$T_a = \frac{F \times P_{ho}}{2000 \times \pi \times \eta}$$

To transform an axial force into torque, we will use the following formulation.

Converting the movement into rotation.

T_a =Motor torque. (Nm).
 η =Mechanical performance (≥ 0.7)

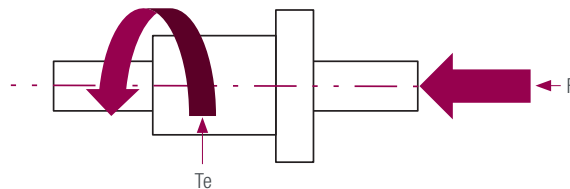

$$T_e = \frac{F \times P_{ho} \times \eta}{2000 \times \pi}$$

The necessary motor torque is considered in many applications as absorbed energy, and in different speed

conditions. To calculate power, we will use the following formula.

T_a =Motor torque. (kW).

η =Mechanical performance (min-1)

$$P_a = \frac{T_a \times \eta}{9550}$$

10.3 | Types of support at end of screws

The placement of one support or another at the ends of the screws is an important factor in terms of making the calculations to correctly configure the screw.

This variation affects the speed, the column load and the total rigidity of the motor unit.

The following different support systems are used for calculations:

1: Fixed-Free

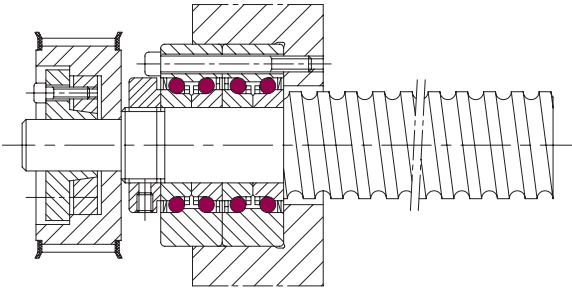

2: Supported-Supported

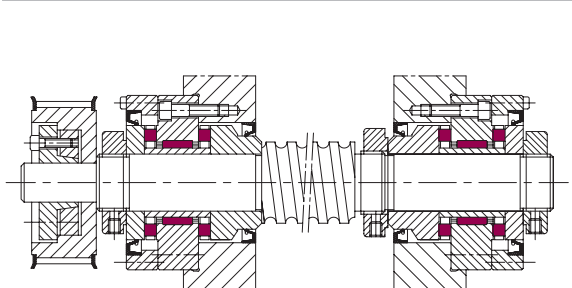
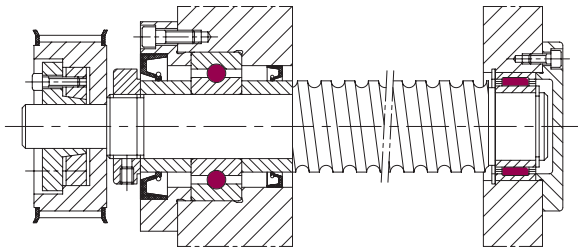

4: Fixed-Fixed

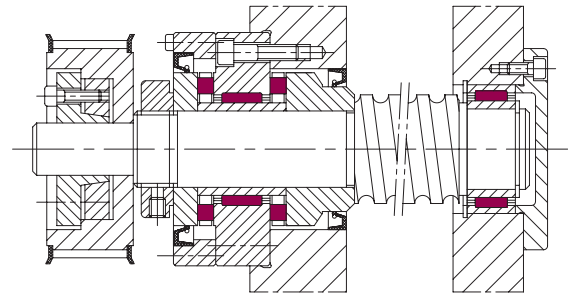

3: Fixed-Supported

10.4 | Critical speed

The critical rotation speed of a ball screw is mainly determined by the length of the screw and the support system at the ends of the screw. This speed may not be surpassed under any circumstances due to the natural

vibration frequency caused by the unbalanced lateral forces. The length, to calculate this, is " L_{ar} ", the supports for the calculation of Fixed and Fixed " $E_{mp-E_{mp}}$ ", Fixed and Supported " $E_{mp-A_{poy}}$ ", Fixed and Free " $E_{mp-libre}$ ".

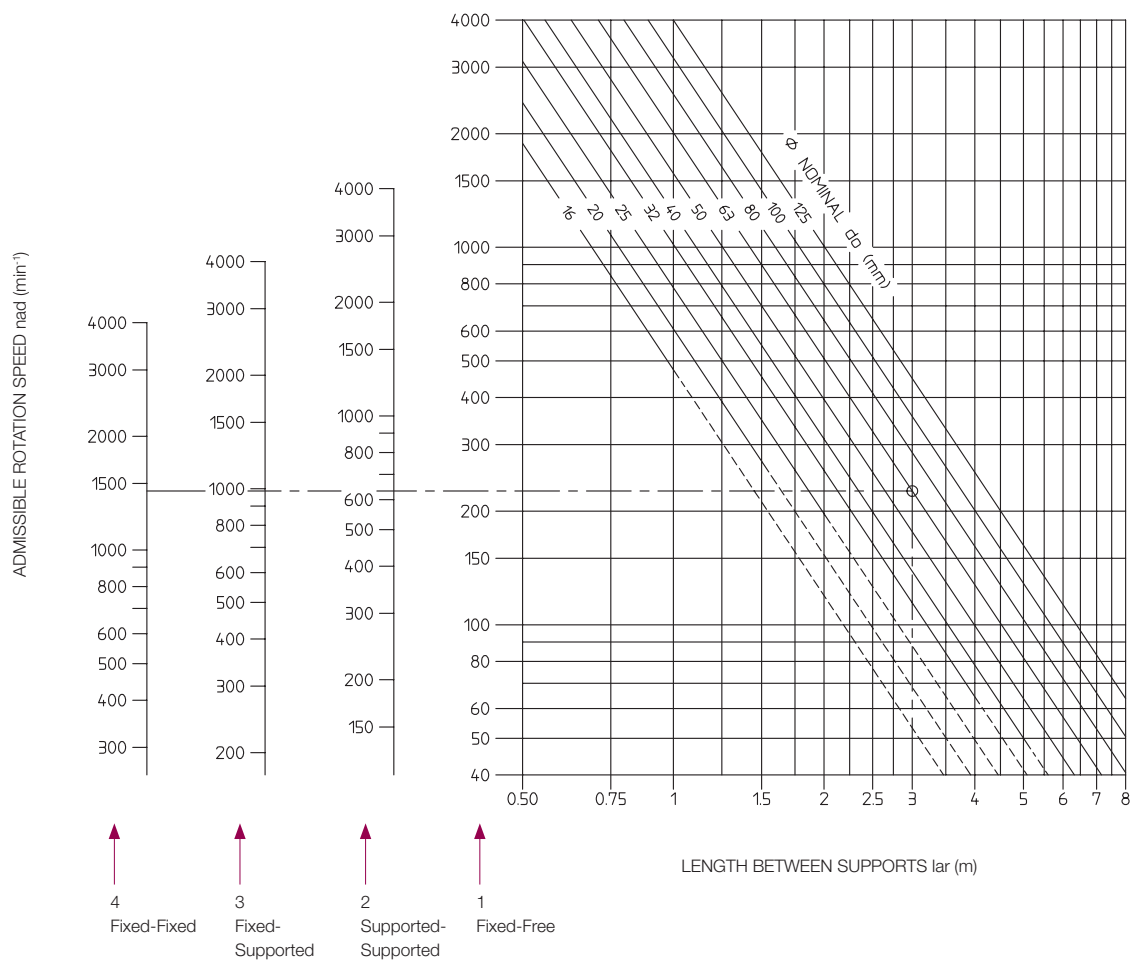

Lar

Maximum distance from the bearing centre to the furthest point where the centre of the nut may be found, from one end or another.

Safety coefficient used: 0.8

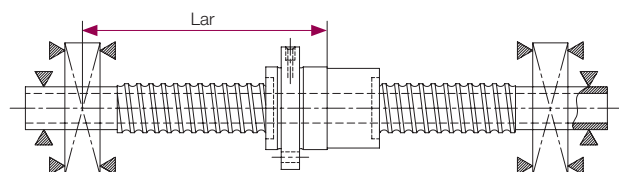

Example

Screw diameter = 63mm
 Lar = 3 metres

Results

Fixed-Free (1) = 225 Rpm
 Supported-Supported (2) = 630 Rpm
 Fixed-Supported (3) = 980 Rpm
 Fixed-Fixed (4) = 1425 Rpm

The peripheral speed of the balls is related to the operating temperature of the screw, that is, all the elements that comprise the screw and the cooling systems intervene. The calculation value is the diameter of the screws by the revolutions "Dn". If we divide this value between the diameter, gives us the maximum rotation revolutions.

Return	DN
S	90000
E	60000
U	90000

$$V_{\max} = \frac{DN}{Do \text{ (mm)}} \text{ Rpm}$$

Example

Screw diameter = 63mm
 Return = S

Results

$V_{\max} = 1428 \text{ Rpm}$

10.5 | Column load

When an axial compression load acts upon a screw, this may buckle due to the disproportion between the diameter and its length.

The column load is the physical compression of the screw. This load depends on the length, diameter and support system at the ends.

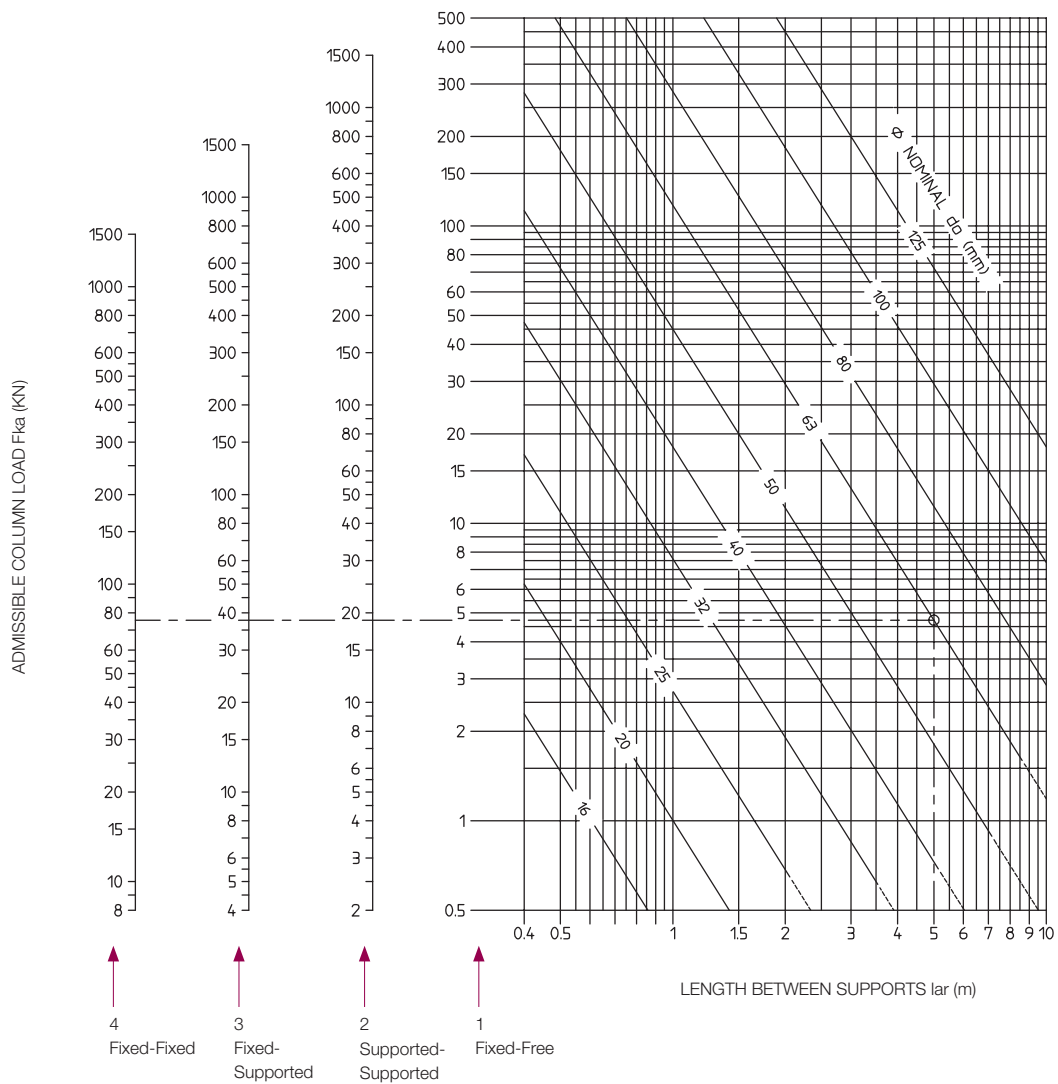

Lar

Maximum distance from the bearing centre to the furthest point where the centre of the nut may be located, from one end or another.

Safety coefficient used: 0.8

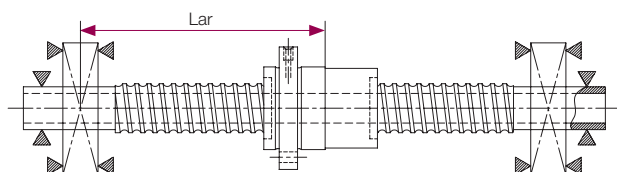

Example

Screw diameter = 63mm

Lar = 3 metres

Results

Fixed-Free (1) = 4,7 KN

Supported-Supported (2) = 18.8 KN

Fixed-Supported (3) = 37.6 KN

Fixed-Fixed (4) = 75.2 KN

10.6 | Rigidity

The axial rigidity of the ball screws is the result of several individual calculations, rigidity of the screw, of the balls and the raceways.

To make these calculations, Hooke's Law is taken into account to understand that there is no plastic deformation, in addition to the simplified Hertz theory.

In working conditions with loads, some deformations occur that affect the machine structure, the bearing assemblies, and the screw and nut unit. These deformations have a value that is represented as axial rigidity, determined by the relationship between applied load and deformation produced.

Δ : Deformation produced (μm)

F: Applied load (N)

R_{tot} : Unit rigidity (N/ μm)

$$\Delta = \frac{F}{R_{\text{tot}}}$$

The nut deformations are minimal due to their compact size.

The screw rigidity depends on the diameter, length and its supports. Due to its length, it is somewhat lower than that of the nuts.

Fixed-free assembly

$R_{s(0)}$: Screw rigidity (N/ μ m)

$L_{s(0)}$: Length between bearing-nut (m)

R_{sm} : Screw rigidity per metre (N/ μ m)

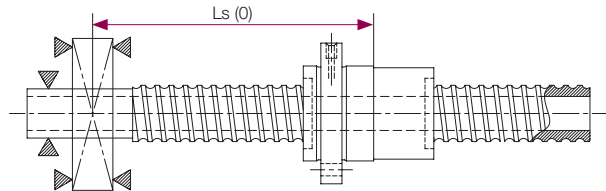

$$R_{s(0)} = \frac{R_{sm}}{L_{s(0)}}$$

Fixed-Fixed assembly

$R_{s(1)}$: Screw rigidity (N/ μ m)

$L_{s(1)}$: Length between bearings (m)

$L_{s(2)}$: Length between bearing-nut (m)

R_{sm} : Screw rigidity per metre (N/ μ m)

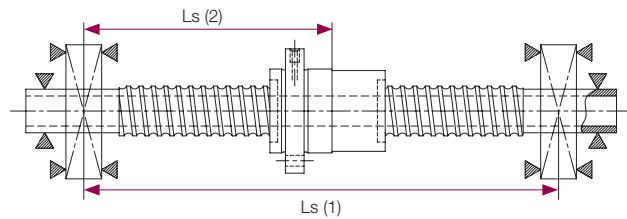

$$R_{s(1)} = R_{sm} \cdot \frac{1}{L_{s(2)}} \cdot \frac{L_{s(1)}}{L_{s(1)} - L_{s(2)}}$$

The point of less rigidity is found with the nut in the bearing centre

$$L_{s(2)} = \frac{L_{s(1)}}{2}$$

Screw-nut unit rigidity

R_s : Screw rigidity (μ m)

$R_{nu.ar}$: Nut rigidity (μ m)

R_{tot} : Unit rigidity (N/ μ m)

$$\frac{1}{R_{tot}} = \frac{1}{R_s} + \frac{1}{R_{nu.ar}}$$

11	NUT HANDLING
-----------	---------------------

The screw and nut units can be disassembled due to different needs.

To carry out this process, the following steps must be taken:

1 Prepare a tube to move the nut from the screw to the tube.

A) Tube dimension

External diameter = $d_3 (+0/-0,1)$

Inner diameter = outer diameter of the tip through where we want to extract the nut, "d (Tip)".

Tube length = Nut length "L (Nut)" x 1.5

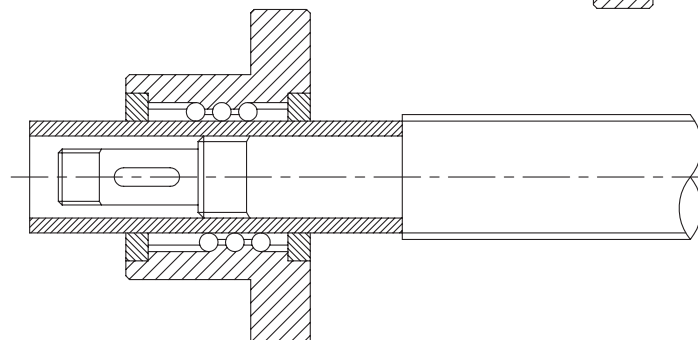
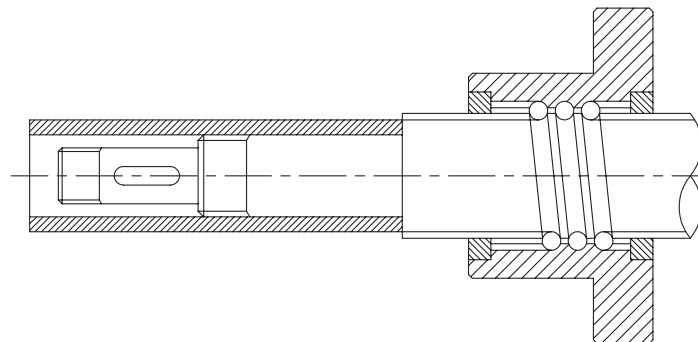
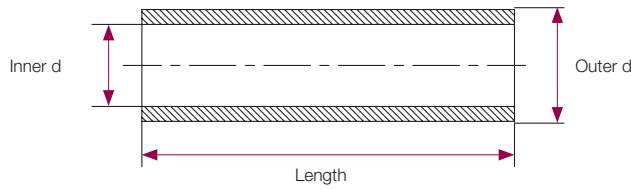
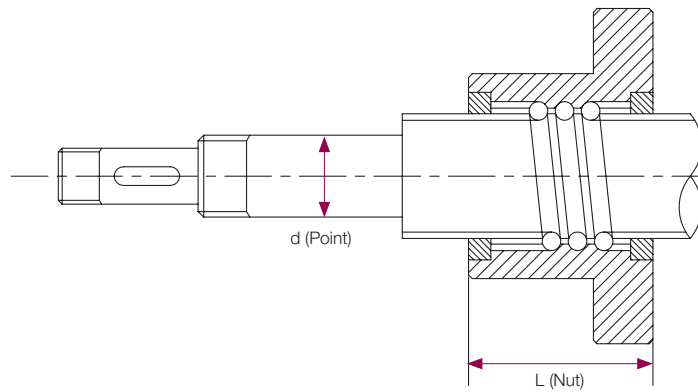

12
CODIFICATION

Series	Diameter	Pitch	Circuits	=	Code
10	16	05	3		10.1605.3

Series

10	Cylindrical nut = standard
12	Flange nut = standard
14	Cylindrical nut = standard multi-starts
16	Flange nut – standard multi-starts
18	Flange nut – DIN 69051
20	Cylindrical nut = DIN 69051

13 DIMENSIONAL TABLES

SERIES 10

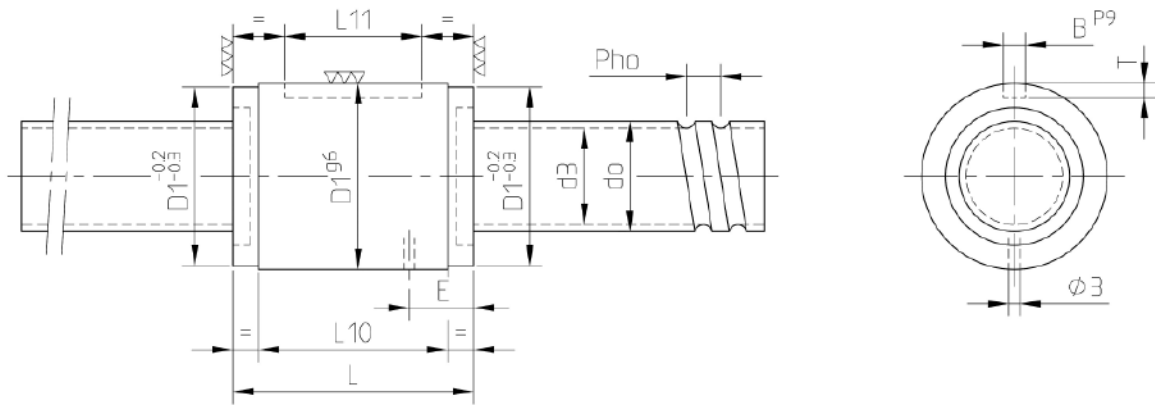

Cylindrical nut	d1	d3	Pho	Starts	Circuits	Dw	D1	L
10.1605.3	15.4	12.7	5	1	3	3.5	28	40
10.2005.3	19.4	16.7	5	1	3	3.5	32	40
10.2505.3	24.4	21.7	5	1	3	3.5	38	40
10.3205.4	31.4	28.7	5	1	4	3.5	45	46
10.3210.3	32.1	27.5	10	1	3	6.35	53	68
10.4005.5	39.3	36.7	5	1	5	3.5	53	51
10.4010.3	39.3	34.1	10	1	3	7.144	63	68
10.5010.5	49.2	44	10	1	5	7.144	72	90
10.6310.5	62.2	57	10	1	5	7.144	85	90
		mm.					mm.	



L10	L11	BxT	E	Dynamic load Cam	Static load Coam	Max. play	Screw rigidity per metre Rsm	Nut rigidity Rnu.ar
25	20	5x2	10	10.5	14.9	0.08	33	93
25	20	5x2	10	12	19.3	0.08	55	113
25	20	5x2	10	14.2	26.6	0.08	89	143
31	25	6x2.5	10	20.6	47.2	0.08	150	228
48	30	6x2.5	13.5	35.4	63	0.12	143	220
36	30	6x2.5	10	27.9	76.1	0.08	239	330
48	30	6x2.5	13.5	43.4	80.3	0.14	217	244
69	40	6x2.5	14.5	79.5	184.3	0.14	352	498
69	40	6x2.5	14.5	88.5	235.5	0.14	578	580
mm.				KN		mm.	N/μm	

SERIES 12

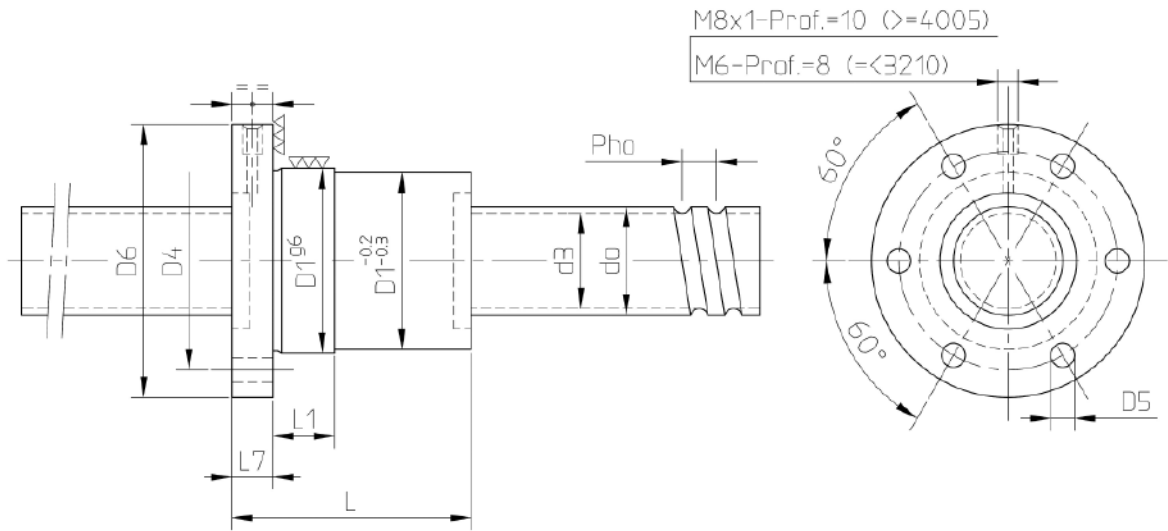

Cylindrical nut	d1	d3	Pho	Starts	Circuits	Dw	D1	D6	D4
12.1605.3	15.4	12.7	5	1	3	3.5	28	48	38
12.2005.3	19.4	16.7	5	1	3	3.5	32	55	45
12.2505.3	24.4	21.7	5	1	3	3.5	38	62	50
12.3205.4	31.4	28.7	5	1	4	3.5	45	70	58
12.3210.3	32.1	27.5	10	1	3	6.35	53	80	68
12.4005.5	39.3	36.7	5	1	5	3.5	53	80	68
12.4010.3	39.3	34.1	10	1	3	7.144	63	95	78
12.5010.5	49.2	44	10	1	5	7.144	72	110	90
12.6310.5	62.2	57	10	1	5	7.144	85	125	105
	mm.						mm		



D5	L	L7	L1	Dynamic load Cam	Static load Coam	Max. play	Screw rigidity per metre Rsm	Nut rigidity Rnu.ar
5.5	46	12	10	10.5	14.9	0.08	33	93
7	46	12	10	12	19.3	0.08	55	113
7	48	14	10	14.2	26.6	0.08	89	143
7	55	16	10	20.6	47.2	0.08	150	228
7	75	16	16	35.4	63	0.12	143	220
7	60	16	10	27.9	76.1	0.08	239	330
9	75	16	16	43.4	80.3	0.14	217	244
11	99	18	16	79.5	184.3	0.14	352	498
11	101	20	16	88.5	235.5	0.14	578	580
mm				KN		mm	N/μm	

SERIES 14

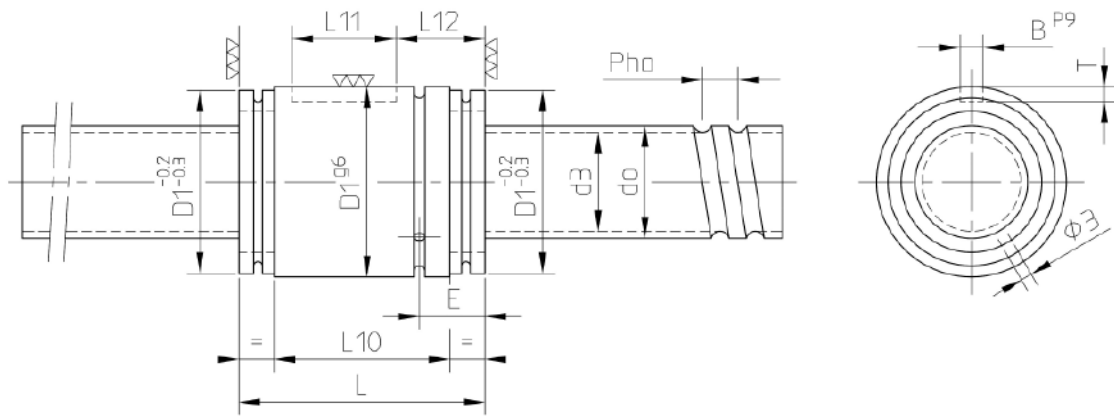

Cylindrical nut	d1	d3	Pho	Starts	Circuits	Dw	D1	L
14.2510.4	24.4	21.9	10	2	4	3.5	45	36
14.2525.5	24.4	21.9	25	5	5	3.5	45	40
14.3220.8	31.4	28.7	20	4	8	3.5	53	55
14.3240.4	31.4	28.7	40	8	4	3.5	53	50
14.4040.4	39.4	34.3	40	4	4	7.144	72	57
14.5020.4	49.4	44	20	2	4	7.144	85	65
14.5050.5	49.4	44.2	50	5	5	7.144	85	66
14.6320.4	62.4	57	20	2	4	7.144	105	65
	mm.						mm.	



L10	L11	L12	BxT	E	Dynamic load Cam	Static load Coam	Max. play	Screw rigidity per metre Rsm	Nut rigidity Rnu.ar
20	12,5	14.5	5x2	11.5	16.3	37.1	0.08	89	190
23	16	14	5x2	10.5	20.7	42.4	0.08	89	227
37	20	17.5	6x2.5	11	32.9	96.4	0.08	150	454
32	20	15	6x2.5	11	17.8	40.5	0.08	150	204
37	20	18.5	6x2.5	15	52.6	102.8	0.14	218	310
45	30	24	6x2.5	20	59	154.3	0.14	355	410
46	30	18	6x2.5	14.5	75.1	176.5	0.14	355	496
47	30	24	6x2.5	20	65.3	195.5	0.14	581	488
mm.					KN		mm.	N/μm	

SERIES 16

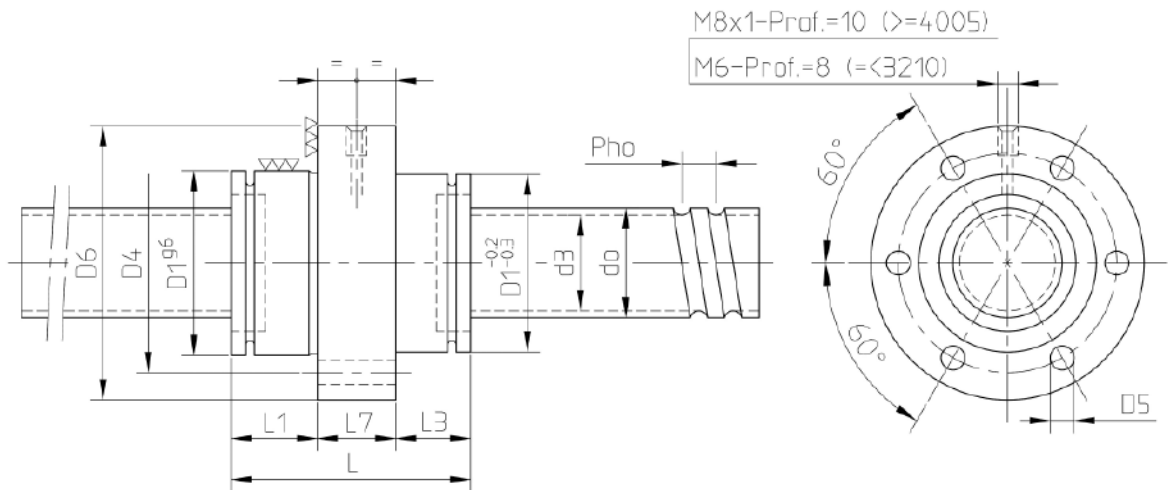

Cylindrical nut	d1	d3	Pho	Starts	Circuits	Dw	D1	D6	D4
16.2510.4	24.4	21.9	10	2	4	3.5	45	70	57
16.2525.5	24.4	21.9	25	5	5	3.5	45	70	57
16.3220.8	31.4	28.7	20	4	8	3.5	53	80	68
16.3240.4	31.4	28.7	40	8	4	3.5	53	80	68
16.4040.4	39.4	34.3	40	4	4	7.144	72	104	87
16.5020.4	49.4	44	20	2	4	7.144	85	125	105
16.5050.5	49.4	44.2	50	5	5	7.144	85	125	105
16.6320.4	62.4	57	20	2	4	7.144	105	145	125
	mm.						mm.		



D5	L	L7	L1	L3	Dynamic load Cam	Static load Coam	Max. play	Screw rigidity per metre Rsm	Nut rigidity Rnu.ar
7	36	14	11	11	16.3	37.1	0.08	89	190
7	40	14	14.5	11.5	20.7	42.4	0.08	89	227
7	55	16	26	13	32.9	96.4	0.08	150	454
7	50	16	21	13	17.8	40.5	0.08	150	204
9	57	16	24	17	52.6	102.8	0.14	218	310
11	65	18	27	20	59	154.3	0.14	355	410
11	66	18	31	17	75.1	176.5	0.14	355	496
11	65	20	27	18	65.3	195.5	0.14	581	488
mm.					KN		mm.	N/μm	



L	L7	L1	L3	L8	Dynamic load Cam	Static load Coam	Max. play	Screw rigidity per metre Rsm	Nut rigidity Rnu.ar
50	10	10	6	40	10.5	14.9	0.08	33	93
50	10	10	6	44	12	19.3	0.08	55	114
55	10	10	6	44	15.3	25.7	0.08	55	150
50	10	10	6	48	14.2	26.6	0.08	89	144
55	10	10	6	48	18.1	35.4	0.08	89	190
57	12	10	6	62	20.6	47.2	0.08	150	234
63	12	10	6	62	25	58.9	0.08	150	289
77	12	10	6	62	35.4	63	0.12	143	218
87	12	10	6	62	45.5	84	0.12	143	288
61	14	10	7	70	23	60.8	0.08	239	282
65	14	10	7	70	27.9	76.1	0.08	239	349
80	14	20	7	70	43.4	80.3	0.14	217	244
90	14	20	7	70	55.6	107.1	0.14	217	321
92	16	20	7	85	65.6	147.4	0.14	352	406
104	16	20	7	85	79.6	184.3	0.14	352	503
114	16	20	7	85	93.1	221.1	0.14	352	599
94	18	20	7	95	73.1	188.3	0.14	578	480
106	18	20	7	95	88.6	235.5	0.14	578	594
116	18	20	7	95	106.3	282.5	0.14	578	707
mm.					KN		mm.	N/μm	

SERIES 20 DIN 69051

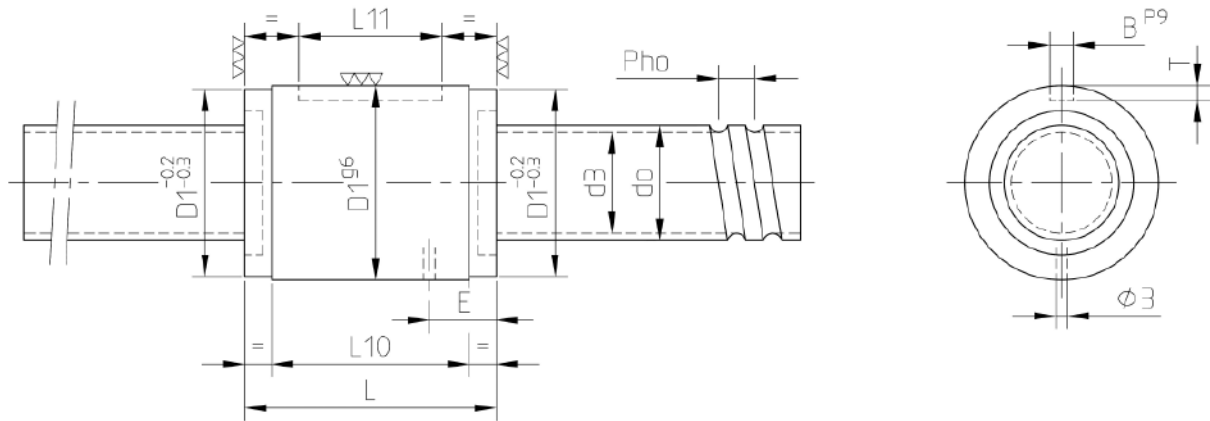

Cylindrical nut	d1	d3	Pho	Starts	Circuits	Dw	D1	L	
20.1605.3	15.4	12.7	5	1	3	3.5	28	40	
20.2005.3	19.4	16.7	5	1	3	3.5	36	40	
20.2005.4	19.4	16.7	5	1	4	3.5	36	46	
20.2505.3	24.4	21.7	5	1	3	3.5	40	40	
20.2505.4	24.4	21.7	5	1	4	3.5	40	46	
20.3205.4	31.4	28.7	5	1	4	3.5	50	46	
20.3205.5	31.4	28.7	5	1	5	3.5	50	51	
20.3210.3	32.1	27.5	10	1	3	6.35	50	68	
20.3210.4	32.1	27.5	10	1	4	6.35	50	78	
20.4005.4	39.3	36.7	5	1	4	3.5	63	46	
20.4005.5	39.3	36.7	5	1	5	3.5	63	51	
20.4010.3	39.3	34.1	10	1	3	7.144	63	68	
20.4010.4	39.3	34.1	10	1	4	7.144	63	78	
20.5010.4	49.2	44	10	1	4	7.144	75	78	
20.5010.5	49.2	44	10	1	5	7.144	75	90	
20.5010.6	49.2	44	10	1	6	7.144	75	100	
20.6310.4	62.2	57	10	1	4	7.144	90	78	
20.6310.5	62.2	57	10	1	5	7.144	90	90	
20.6310.6	62.2	57	10	1	6	7.144	90	100	
	mm.						mm.		



L10	L11	BxT	E	Dynamic load Cam	Static load Coam	Max. play	Screw rigidity per metre Rsm	Nut rigidity Rnu.ar
25	20	5x2	10	10.5	14.9	0.08	33	93
25	20	5x2	10	12	19.3	0.08	55	114
25	20	5x2	10	15.3	25.7	0.08	55	150
25	20	5x2	10	14.2	26.6	0.08	89	144
25	20	5x2	10	18.1	35.4	0.08	89	190
31	25	6x2.5	10	20,6	47.2	0.08	150	234
31	25	6x2.5	10	25	58.9	0.08	150	289
48	30	6x2.5	13.5	35.4	63	0.12	143	218
48	30	6x2.5	13.5	45.5	84	0.12	143	288
36	30	6x2.5	10	23	60.8	0.08	239	282
36	30	6x2.5	10	27.9	76.1	0.08	239	349
48	30	6x2.5	13.5	43.4	80.3	0.14	217	244
48	30	6x2.5	13.5	55.6	107.1	0.14	217	321
69	40	6x2.5	14.5	65.6	147.4	0.14	352	406
69	40	6x2.5	14.5	79.6	184.3	0.14	352	503
69	40	6x2.5	14.5	93.1	221.1	0.14	352	599
69	40	6x2.5	14.5	73.1	188.3	0.14	578	480
69	40	6x2.5	14.5	88.6	235.5	0.14	578	594
69	40	6x2.5	14.5	106.3	282.5	0.14	578	707
				KN		mm.		N/μm





HUSILLOS IPIRANGA S.L.

Polígono Industrial Erratzu
Pabellón 221, Apdo. 65
20130 URNIETA (Spain)

Tel.: +34 943 336 370

Fax: +34 943 336 373

comercial@ipirangahusillos.com



NADELLA / nadella.com

DURBAL / durbal.de

CHIAVETTE UNIFICATE / chiavette.com

IPIRANGA / ipirangahusillos.com

SHUTON / shuton.com

THE SPECIALIST FOR MOTION TECHNOLOGY

